



# 1/2"x2" Square Plate Washer

6482215

Units Inch[mm]

Scale 1/4

Drawn Shannon Kimes

Date 4/25/2026

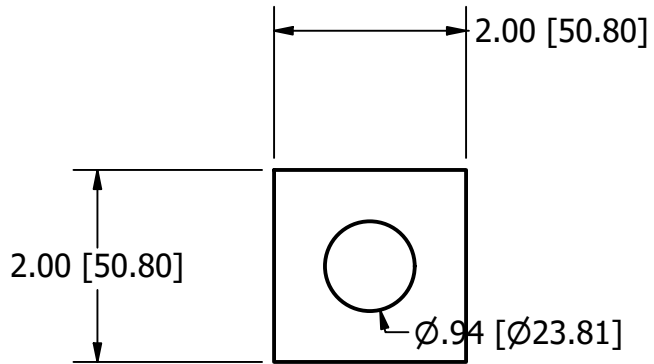
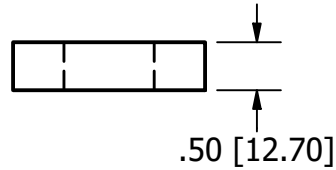
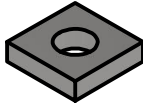

Material		Packaging		Notes
Base Material: Steel, Carbon		Weight lbs[kgs]	Units	1. Weights approximation/theoretical.
Finish: Plain/None	Piece	0.57[0.26]	1 Piece	
Coating: Oiled	Bag	50[22.7]	88 pcs	
	Pallet	2500[1134]	50 Bags	
	Ton[MT]	2,000[1,000]	3530[3883] pcs	