



1-1/4"x22" Single End Stud

6312022

Units Inch[mm]

Scale 1/4

Drawn Shannon Kimes

Date 3/21/2026

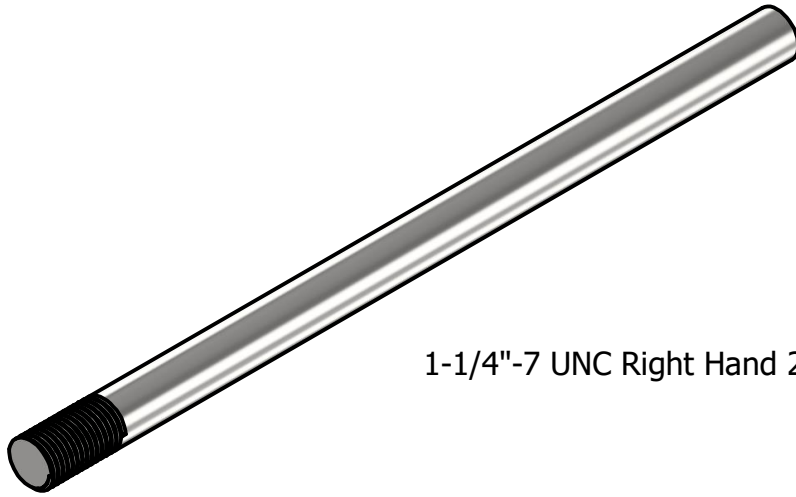

$\varnothing 1.25$ [$\varnothing 31.75$]

1-1/4"-7 UNC Right Hand 2A

2.06 [52.38]

22.00 [558.80]

Material

Packaging

Notes

Base Material: Steel, Carbon

Weight lbs[kgs]

Units

1. Weights approximation/theoretical.

Finish: Plain/None

Piece

7.65[3.47]

1 Piece

Coating: Oiled

Bag

50[23]

7 pcs

Pallet

2500[1134]

50 Bags

Ton[MT]

2,000[1,000]

261[288] pcs