



1-1/8"x22" Single End Stud

6311822

Units Inch[mm]

Scale 1/4

Drawn Shannon Kimes

Date 3/21/2026

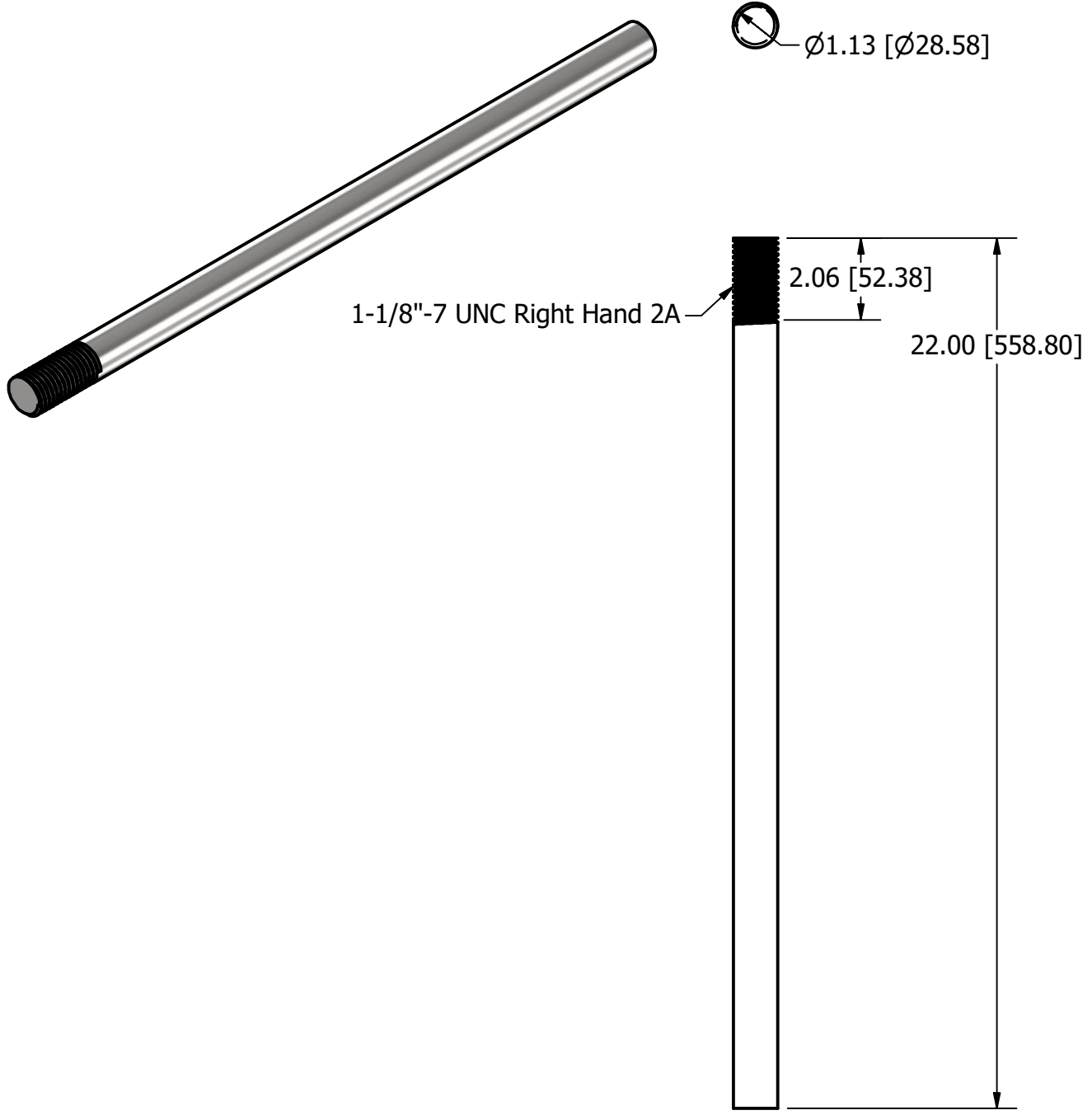

Material		Packaging		Notes
Base Material: Steel, Carbon		Weight lbs[kgs]	Units	1. Weights approximation/theoretical.
Finish: Plain/None	Piece	6.2[2.81]	1 Piece	
Coating: Oiled	Bag	50[23]	8 pcs	
	Pallet	2500[1134]	50 Bags	
	Ton[MT]	2,000[1,000]	323[355] pcs	