



# 1-1/8"x24" Single End Stud

6311824

Units Inch[mm]

Scale 1/4

Drawn Shannon Kimes

Date 3/21/2026

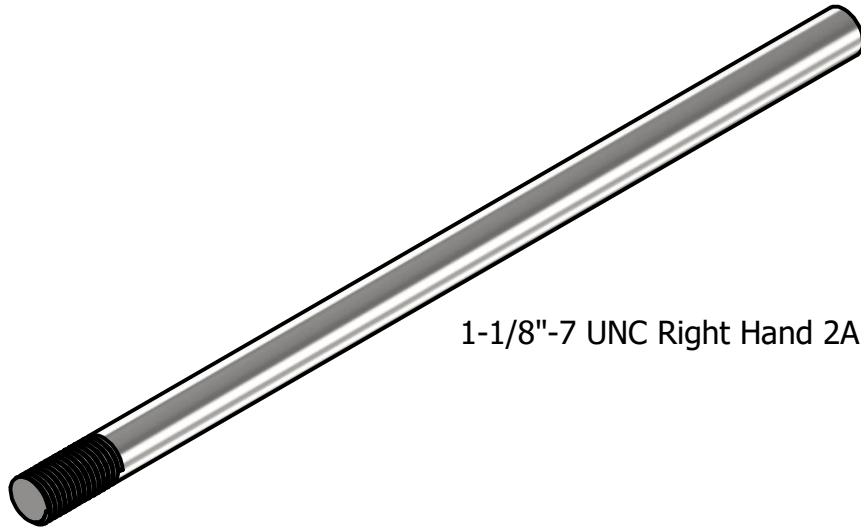

$\varnothing 1.13$  [ $\varnothing 28.58$ ]

1-1/8"-7 UNC Right Hand 2A

2.06 [52.38]

24.00 [609.60]

## Material

## Packaging

## Notes

Base Material: Steel, Carbon

Weight lbs[kgs]

Units

1. Weights approximation/theoretical.

Finish: Plain/None

Piece

6.76[3.07]

1 Piece

Coating: Oiled

Bag

50[23]

7 pcs

Pallet

2500[1134]

50 Bags

Ton[MT]

2,000[1,000]

296[326] pcs