



3/4"x20" Single End Stud

6311220

Units Inch[mm]

Scale 1/4

Drawn Shannon Kimes

Date 3/21/2026

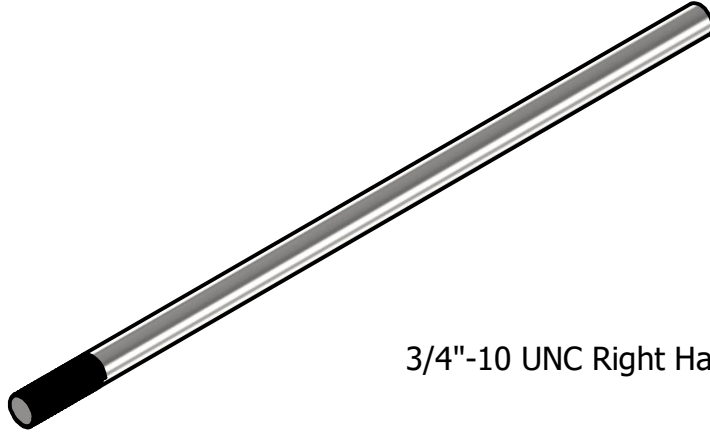

$\varnothing .75$ [$\varnothing 19.05$]

3/4"-10 UNC Right Hand 2A

2.06 [52.20]

20.00 [508.00]

Material

Packaging

Notes

Base Material: Steel, Carbon

Weight lbs[kgs]

Units

1. Weights approximation/theoretical.

Finish: Plain/None

Piece

2.5[1.14]

1 Piece

Coating: Oiled

Bag

50[23]

20 pcs

Pallet

2500[1134]

50 Bags

Ton[MT]

2,000[1,000]

799[879] pcs