



# 7/8"x20" Single End Stud

6311420

Units Inch[mm]

Scale 1/4

Drawn Shannon Kimes

Date 3/21/2026

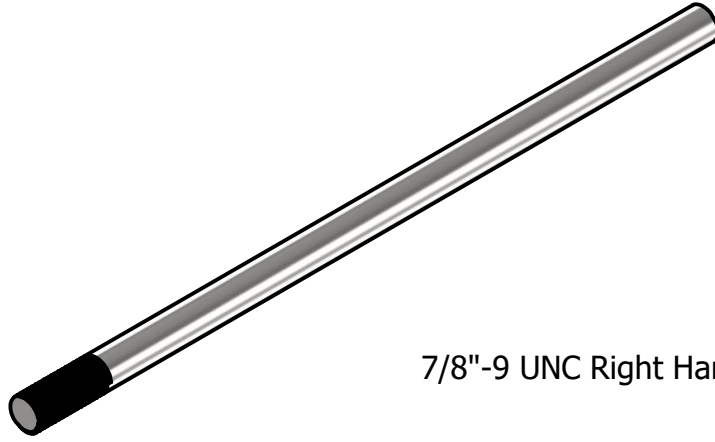

$\varnothing .88$  [ $\varnothing 22.23$ ]

7/8"-9 UNC Right Hand 2A

1.59 [40.30]

20.00 [508.00]

## Material

## Packaging

## Notes

Base Material: Steel, Carbon

Weight lbs[kgs]

Units

1. Weights approximation/theoretical.

Finish: Plain/None

Piece

3.41[1.55]

1 Piece

Coating: Oiled

Bag

50[23]

15 pcs

Pallet

2500[1134]

50 Bags

Ton[MT]

2,000[1,000]

587[646] pcs